

INSTALLATION AND CARE INSTRUCTIONS

Insulated Cordless Roman Shade

WARNING

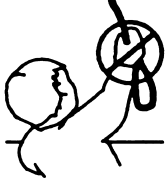

CHILDREN CAN STRANGLE IN WINDOW BLIND OR DRAPERY CORDS.

TO SECURE CORDS OUT OF REACH OF YOUR CHILDREN, USE ONE OF THESE SUGGESTED METHODS:



CLAMP OR CLOTHES PIN



CLEAT ON WALL OR WINDOW FRAME



TIE CORD TO ITSELF.

ALWAYS ADJUST CORDS TO THE SHORTEST LENGTH POSSIBLE. PLACE CRIBS OR FURNITURE AWAY FROM WINDOWS TO HELP KEEP CHILDREN AT A SAFE DISTANCE FROM CORDS.

PACKAGE CONTENTS

- One spring roller shade on headrail.
- One mounting bracket kit. Mounting bracket kit includes:

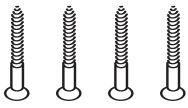

(4) four screws

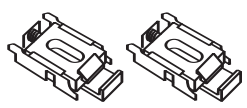

(2) two shade brackets

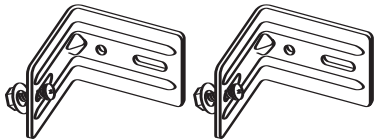

(2) two outside mount L brackets

INSTALLATION

Bracket Location & Installation

Decide whether your shade will be mounted *outside* or *inside* the window frame.

Inside Mount

Place shade bracket with spring loaded plastic tooth facing outward as shown. Bracket should be secured 3" inside the outer edge of where the end of the shade head rail will lie. Repeat this step to install the second bracket at the other side of the window frame.

When brackets are securely mounted, proceed to "Securing the Headrail to the Brackets."

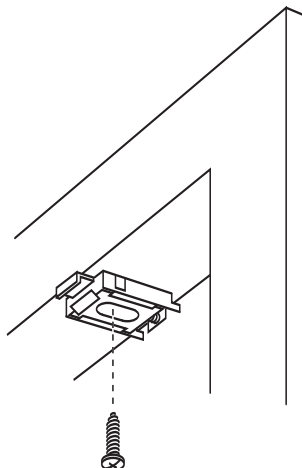

Outside Mount

1. Screw "L" bracket window molding as shown. The 3" side of the "L" bracket should be secured to the window molding, so that the 2" side of the "L" bracket projects from the wall. "L" Bracket should be secured 3" inside the outer edge of where the end of the shade head rail will lie. Repeat this step to install the second bracket at the other side of the window frame.

2. Attach the shade brackets snugly to the "L" brackets as shown. The spring loaded plastic tooth should be facing outward.

When brackets are securely mounted, proceed to "Securing the Headrail to the Brackets."

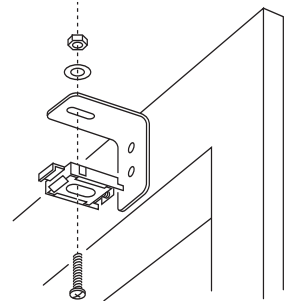
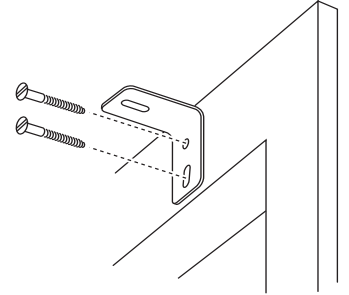

Securing the Headrail to the Brackets:

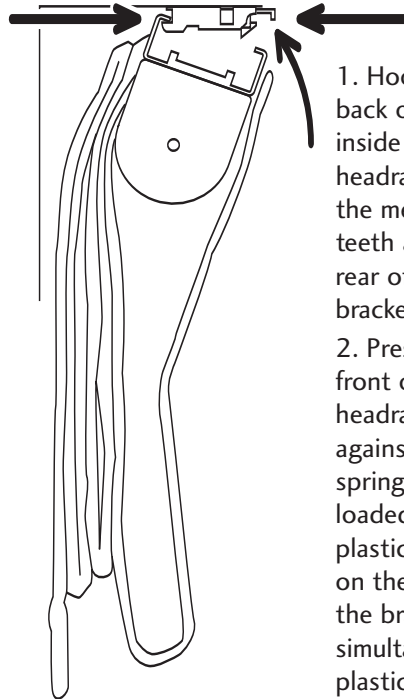

1. Hook the back of the inside of the headrail onto the metal teeth at the rear of the brackets.

2. Press the front of the headrail against the spring-loaded plastic tooth on the front of the bracket while simultaneously pressing the plastic tooth towards the window.

When headrail is flush with the brackets release the pressure from the spring loaded plastic tooth and headrail should be firmly in place and ready for use.

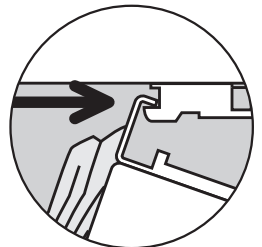

OPERATION

Your cordless roman shade operates with a deluxe spring loaded retracting mechanism. The height or length of the shade is controlled by simply pulling the center control line until the shade reaches the desired length. Pull again gently and the shade will lock in place. To raise the shade, gently pull the center control downward and the shade will rise completely.

CLEANING

Use feather duster or lightly vacuum with a soft brush attachment.



Green Mountain Vista

Green Mountain Vista, Burlington, Vermont 05401
www.gmvista.com